

CLASSIC DUO OVAL

- pure simplicity and unpretentious elegance are what distinguish these baths
- bathing with a friend: two identical back rests and centrally positioned waste
- made of KALDEWEI steel enamel

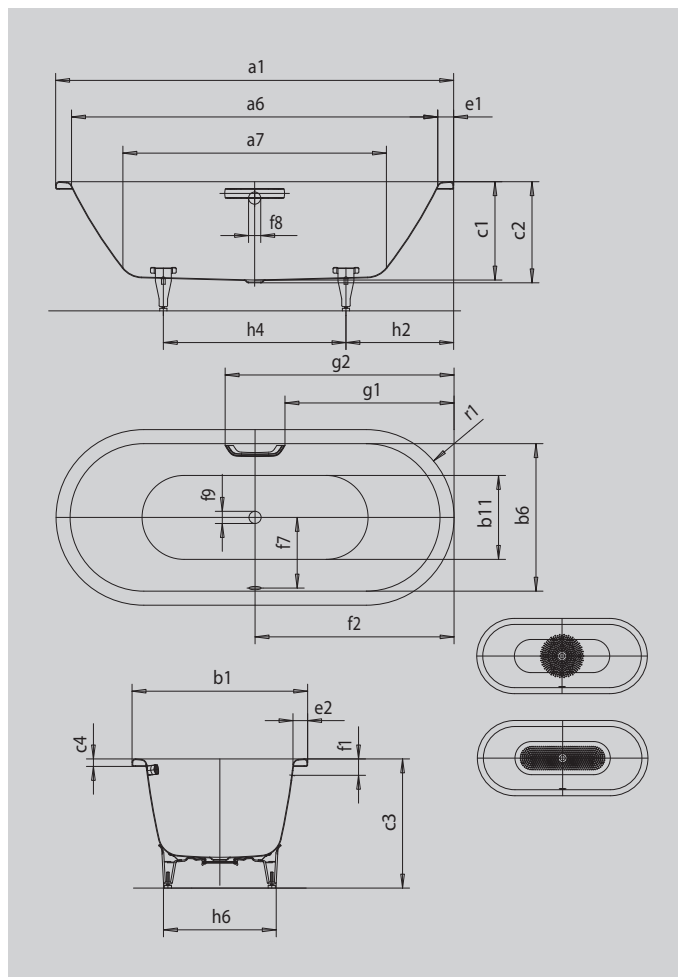

Similar illustration



Model		111
External length	a ₁	1800 mm
Internal length (top)	a ₆	1680 mm
Internal length (bottom)	a ₇	1230 mm
External width	b ₁	800 mm
Internal width (top)	b ₆	680 mm
Internal width (bottom)	b ₁₁	550 mm
Depth inside	c ₁	420 mm
Depth incl. waste hole	c ₂	430 mm
Height with feet	c ₃	555 - 590 mm
Height of rim	c ₄	32 mm
Width of rim (foot end; long side)	e ₁ ; e ₂	60; 60 mm
Distance top edge to centre of overflow hole	f ₁	70 mm
Distance bath edge to centre of waste hole	f ₂	900 mm
Distance centre of waste hole to centre of overflow hole	f ₇	330 mm
Diameter of overflow hole	f ₈	Ø 52 mm
Diameter of waste hole	f ₉	Ø 52 mm
Distance bath edge (foot end) to start of grip	g ₁	772 mm
Distance bath edge (foot end) to end of grip	g ₂	1028 mm
Distance foot end of bath edge to centre of foot	h ₂	600 mm
Distance between the feet	h ₄	600 mm
Width of feet max.	h ₆	540 mm
External radius	r ₁	400 mm
Water volume		158 l
Net weight		50 kg
Diameter of anti-slip		Ø 435 mm
Full anti-slip		900 x 300 mm