

MEISTERSTÜCK

CENTRO DUO 1 LEFT

CORNER INSTALLATION LEFT (2-SIDED)

- bath made of high-quality steel enamel with enamelled panelling on two sides
- specially designed for corner installation
- available as right or left-hand model
- with exclusive easy-clean finish
- pure simplicity and unpretentious elegance are what distinguish these baths
- enamelled waste cover and overflow knob integrated in the bath design (also available with filling function)
- made of KALDEWEI steel enamel



Similar illustration

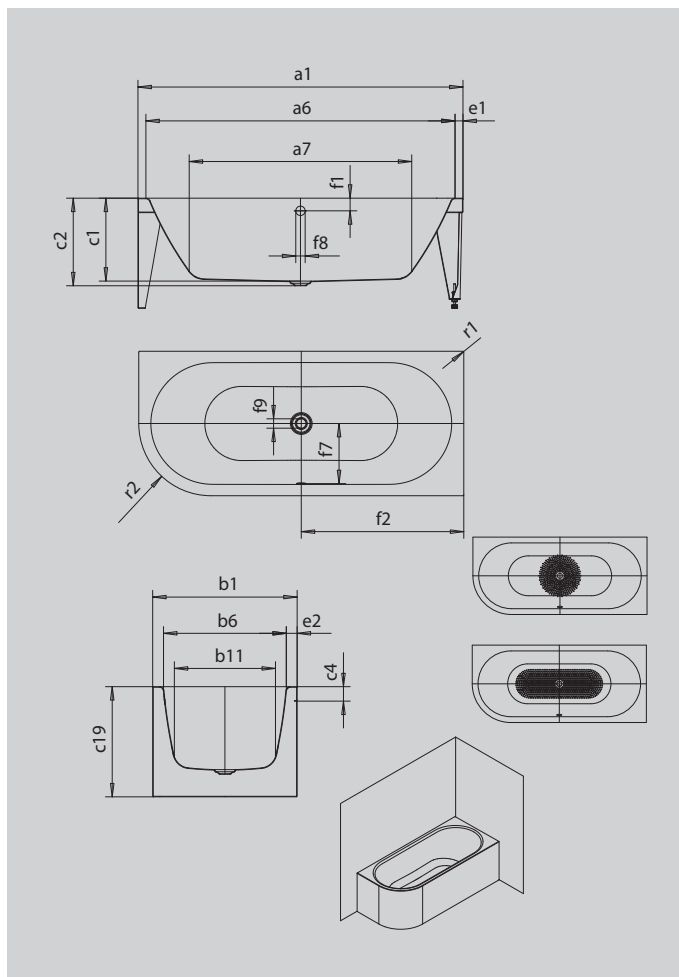

Model		1129
External length	a_1	1700 mm
Internal length (top)	a_6	1580 mm
Internal length (bottom)	a_7	1130 mm
External width	b_1	750 mm
Internal width (top)	b_6	630 mm
Internal width (bottom)	b_{11}	510 mm
Depth inside	c_1	460 mm
Depth incl. waste hole	c_2	485 mm
Height of rim	c_4	80 mm
Height of bath	c_{19}	610 mm
Width of rim (foot end; long side)	e_1, e_2	60; 60 mm
Distance top edge to centre of overflow hole	f_1	70 mm
Distance bath edge to centre of waste hole	f_2	850 mm
Distance centre of waste hole to centre of overflow hole	f_7	307 mm
Diameter of overflow hole	f_8	Ø 52 mm
Diameter of waste hole	f_9	Ø 52 mm
External radius	r_1	5 mm
External radius	r_2	375 mm
Water volume		156 l
Waste connection diameter		Ø 40/50
Fill fitting connection		1/2"
Net weight		99 kg
Diameter of anti-slip		Ø 435 mm
Full anti-slip		900 x 300 mm