

MEISTERSTÜCK CONODUO 1 RIGHT CORNER INSTALLATION (2-SIDED)

- bath made of high-quality steel enamel with enamelled panelling on two sides
- specially designed for corner installation
- available as right or left-hand model
- with exclusive easy-clean finish
- straightlined, purist design
- enamelled waste cover and overflow knob integrated in the bath design (also available with filling function)
- made of KALDEWEI steel enamel
- designed by Sottsass Associati

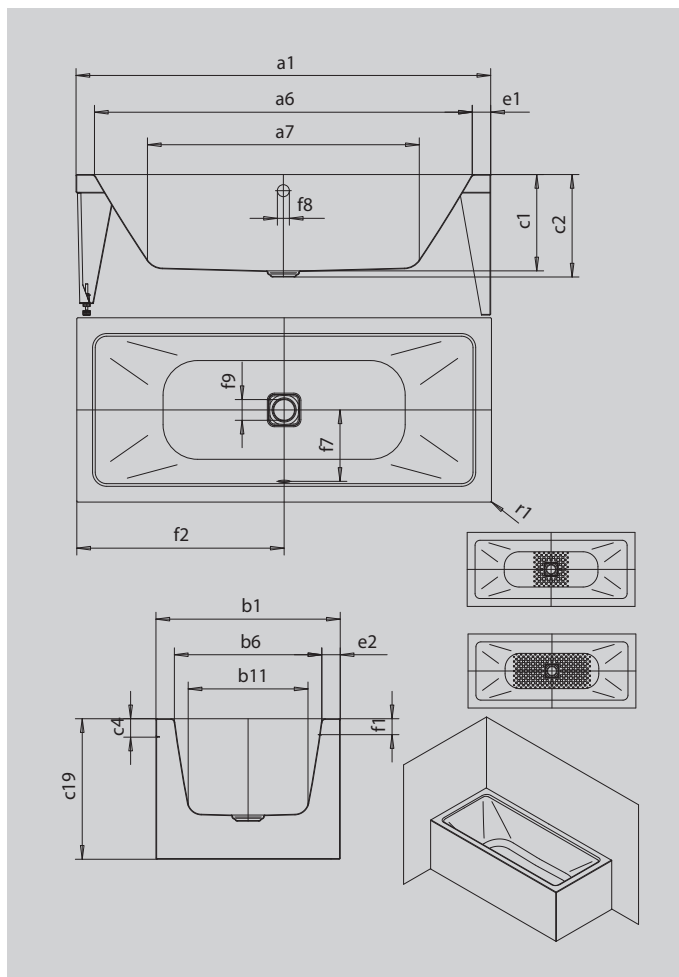

Similar illustration



Model		1712
External length	a ₁	1700 mm
Internal length (top)	a ₆	1540 mm
Internal length (bottom)	a ₇	1080 mm
External width	b ₁	750 mm
Internal width (top)	b ₆	590 mm
Internal width (bottom)	b ₁₁	470 mm
Depth inside	c ₁	420 mm
Depth incl. waste hole	c ₂	445 mm
Height of rim	c ₁	80 mm
Height of bath	c ₁₉	610 mm
Width of rim (foot end; long side)	e ₁ ; e ₂	80; 80 mm
Distance top edge to centre of overflow hole	f ₁	70 mm
Distance bath edge to centre of waste hole	f ₂	850 mm
Distance centre of waste hole to centre of overflow hole	f ₇	285 mm
Diameter of overflow hole	f ₈	Ø 52 mm
Diameter of waste hole	f ₉	Ø 90 mm
External radius	r ₁	5 mm
Water volume		122 l
Waste connection diameter		Ø 40/50
Fill fitting connection		1/2"
Net weight		100 kg
Anti-slip		356 x 356 mm
Full anti-slip		788 x 356 mm