

MEISTERSTÜCK CONODUO 2

FRONT WALL INSTALLATION (3-SIDED)

- bath made of high-quality steel enamel with enamelled panelling on three sides
- with exclusive easy-clean finish
- straightlined, purist design
- enamelled waste cover and overflow knob integrated in the bath design (also available with filling function)
- made of KALDEWEI steel enamel
- designed by Sottsass Associati



Similar illustration

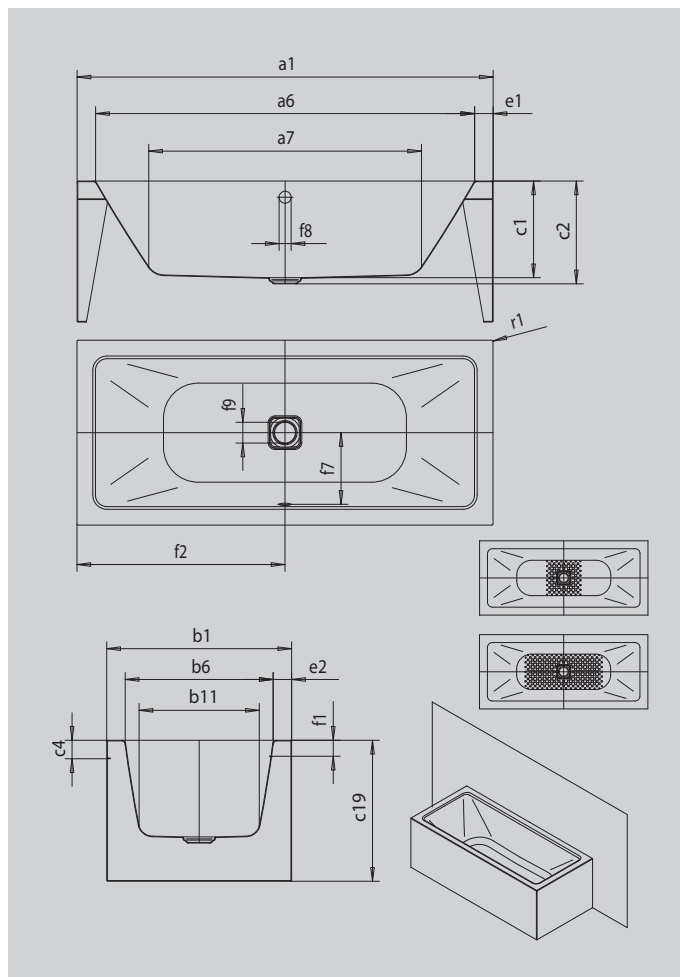

Model		1723
External length	a_1	1800 mm
Internal length (top)	a_6	1640 mm
Internal length (bottom)	a_7	1180 mm
External width	b_1	800 mm
Internal width (top)	b_6	640 mm
Internal width (bottom)	b_{11}	520 mm
Depth inside	c_1	420 mm
Depth incl. waste hole	c_2	445 mm
Height of rim	c_4	80 mm
Height of bath	c_{19}	610 mm
Width of rim (foot end; long side)	$e_1; e_2$	80; 80 mm
Distance top edge to centre of overflow hole	f_1	70 mm
Distance bath edge to centre of waste hole	f_2	900 mm
Distance centre of waste hole to centre of overflow hole	f_7	310 mm
Diameter of overflow hole	f_8	Ø 52 mm
Diameter of waste hole	f_9	Ø 90 mm
External radius	r_1	5 mm
Water volume		159 l
Waste connection diameter		Ø 40/50
Fill fitting connection		1/2"
Net weight		118 kg
Anti-slip		404 x 404 mm
Full anti-slip		884 x 404 mm