

DUSCHPLAN

- a classic among shower trays
- modern, clear design only 65 mm deep
- available in rectangular or square design
- made of KALDEWEI steel enamel
- flush-fitting recessed waste cover (only in combination with the KA 90 waste fittings)

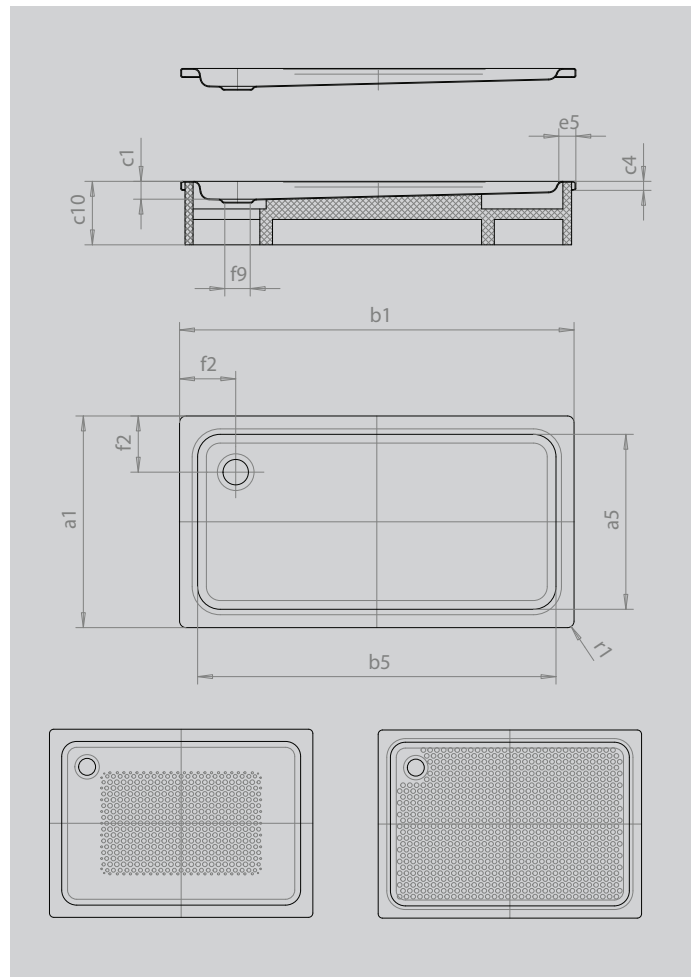

Similar illustration



Model		426
External length	a_1	750 mm
Internal length	a_5	670 mm
External width	b_1	1700 mm
Internal width	b_5	1570 mm
Depth inside	c_1	65 mm
Height of rim	c_4	32 mm
Height with support	c_{10}	160 mm
Height with low-profile support	c_{16}	49 mm
Width of rim	e_5	65 mm
Distance bath edge to centre of waste hole	f_2	200 mm
Diameter of waste hole	f_9	Ø90 mm
External radius	r_1	12 mm
Net weight		36 kg
Anti-slip		300 x 856 mm
Full anti-slip		555 x 1501 mm