

SANIDUSCH

- a classic among shower trays
- modern, clear design
- available in rectangular or square design
- made of KALDEWEI steel enamel

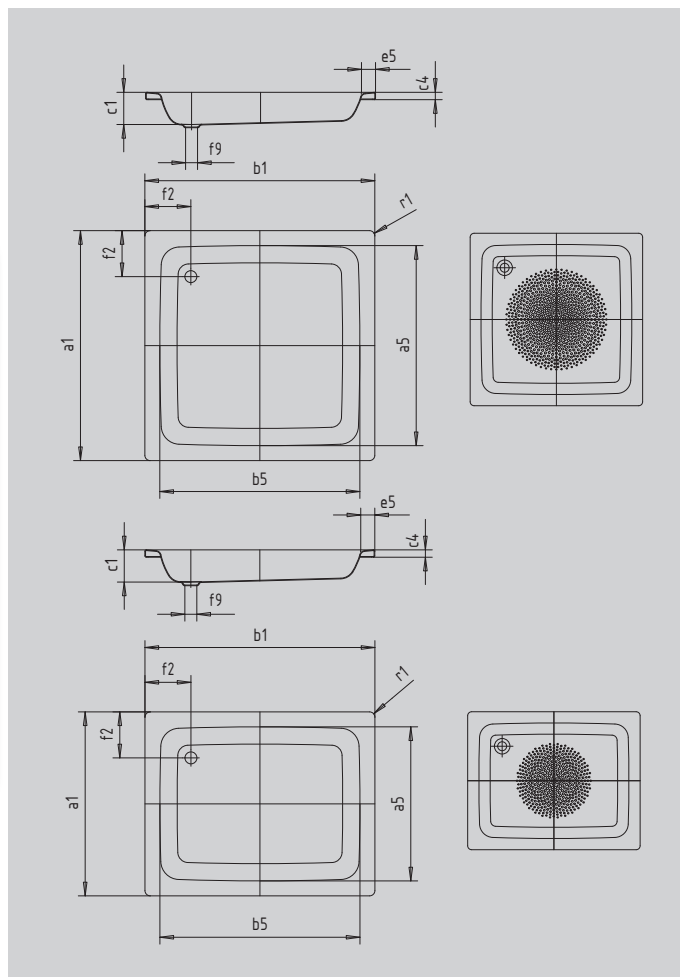

Similar illustration



Model		539
External length	a_1	700 mm
Internal length	a_5	570 mm
External width	b_1	900 mm
Internal width	b_5	770 mm
Depth inside	c_1	140 mm
Height of rim	c_4	32 mm
Height with low-profile support	c_{16}	49 mm
Width of rim	e_5	65 mm
Distance bath edge to centre of waste hole	f_2	200 mm
Diameter of waste hole	f_9	Ø 52 mm
External radius	r_1	12 mm
Net weight		20 kg
		1 kg
Diameter of anti-slip		Ø 435 mm