

# SANIDUSCH

- a classic among shower trays
- modern, clear design
- available in rectangular or square design
- made of KALDEWEI steel enamel

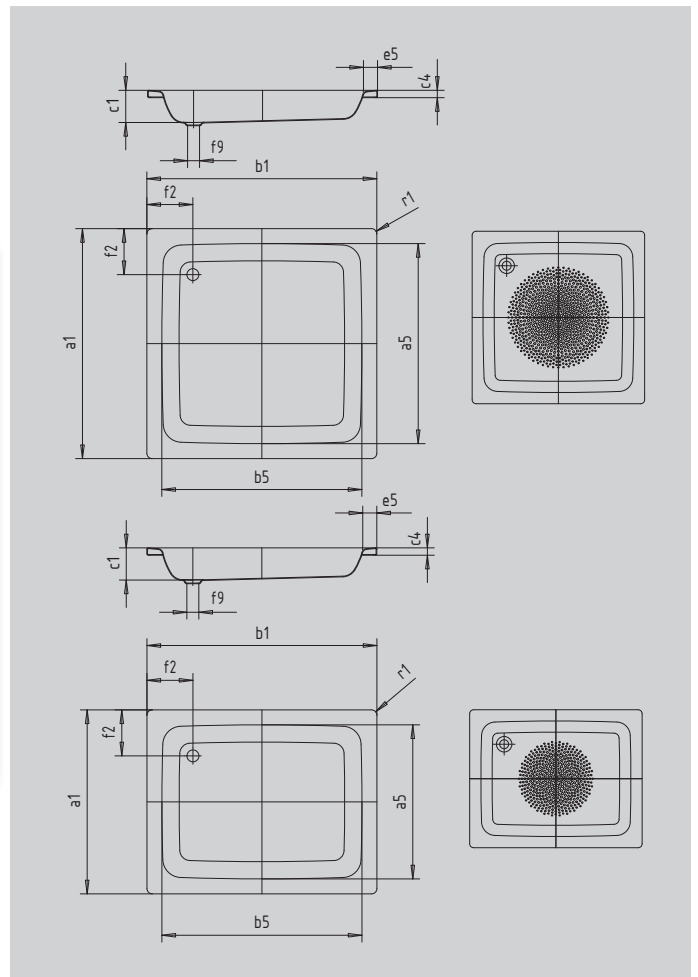

Similar illustration



Model		552
External length	$a_1$	800 mm
Internal length	$a_5$	670 mm
External width	$b_1$	1200 mm
Internal width	$b_5$	1070 mm
Depth inside	$c_1$	140 mm
Height of rim	$c_4$	32 mm
Height with low-profile support	$c_{16}$	49 mm
Width of rim	$e_5$	65 mm
Distance bath edge to centre of waste hole	$f_2$	200 mm
Diameter of waste hole	$f_9$	Ø 52 mm
External radius	$r_1$	12 mm
Net weight		28 kg
		1 kg
Diameter of anti-slip		Ø 435 mm