

SANIDUSCH

- a classic among shower trays
- modern, clear design
- available in rectangular or square design
- made of KALDEWEI steel enamel

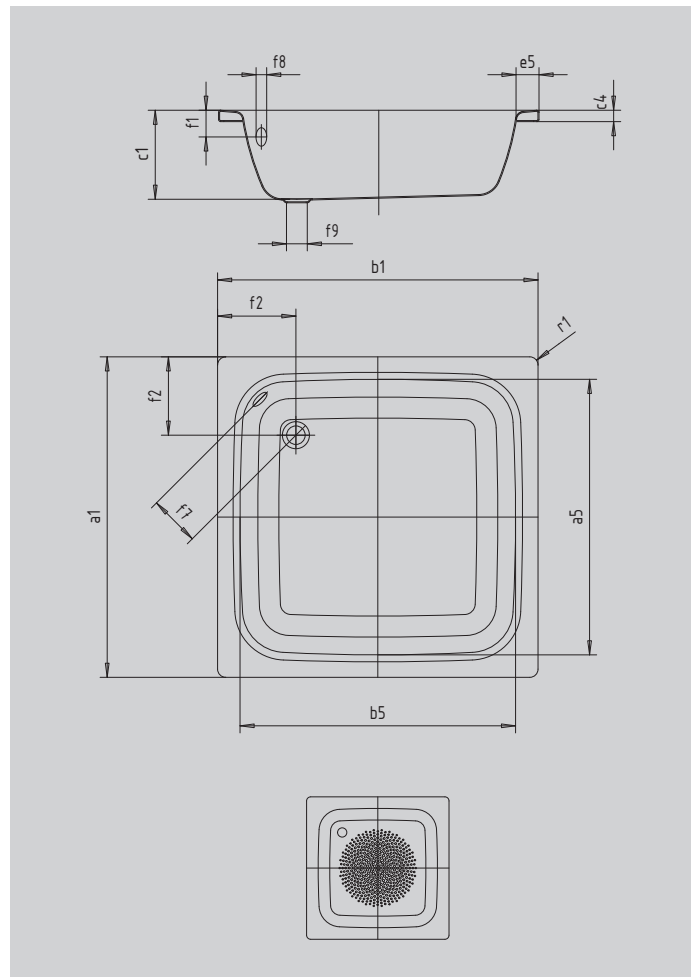

Similar illustration



Model		559
External length	a_1	750 mm
Internal length	a_5	620 mm
External width	b_1	900 mm
Internal width	b_5	770 mm
Depth inside	c_1	250 mm
Height of rim	c_1	32 mm
Height with low-profile support	c_{16}	49 mm
Width of rim	e_5	65 mm
Distance top edge to centre of overflow hole	f_1	75 mm
Distance bath edge to centre of waste hole	f_2	220 mm
Distance centre of waste hole to centre of overflow hole	f_7	125 mm
Diameter of overflow hole	f_8	Ø 52 mm
Diameter of waste hole	f_9	Ø 52 mm
External radius	r_1	12 mm
Net weight		26 kg
		1 kg
Diameter of anti-slip		Ø 289 mm