

SUPERPLAN

- exclusive, elegant design
- made of KALDEWEI steel enamel
- flush-fitting recessed waste cover (only in combination with the KA 90 waste fittings)

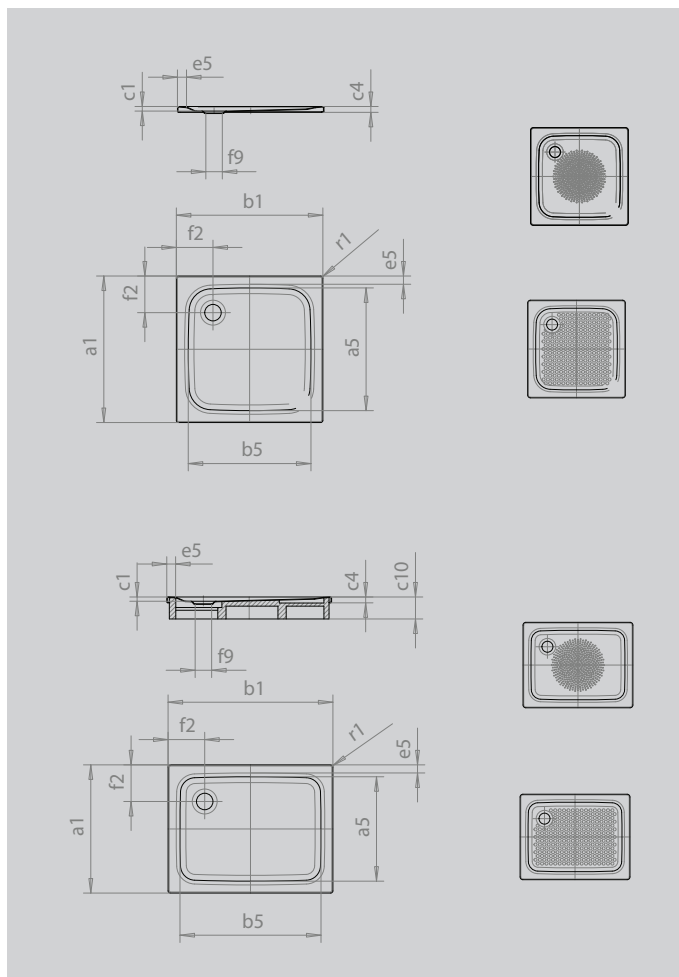

Similar illustration



SECURE⁺

Model		386
External length	a_1	800 mm
Internal length	a_5	690 mm
External width	b_1	800 mm
Internal width	b_5	690 mm
Depth inside	c_1	25 mm
Height of rim	c_4	32 mm
Height with support	c_{10}	120 mm
Height with low-profile support	c_{16}	49 mm
Width of rim	e_{10}, e_5	50; 50 mm
Diameter of waste hole	f_9	Ø 90 mm
Distance bath edge to centre of waste hole	f_2, f_3	200; 200 mm
External radius	r_1	12 mm
Net weight		18 kg
Diameter of anti-slip		Ø 435 mm
Full anti-slip		586 x 565 mm
SECUREPLUS		full base

KALDEWEI