

CORNEZZA

- striking pentagonal shower tray
- space-saving shape
- generous standing area with lots of room to move when showering
- elegant corner solution
- made of KALDEWEI steel enamel
- flush-fitting recessed waste cover (only in combination with the KA 90 waste fittings)

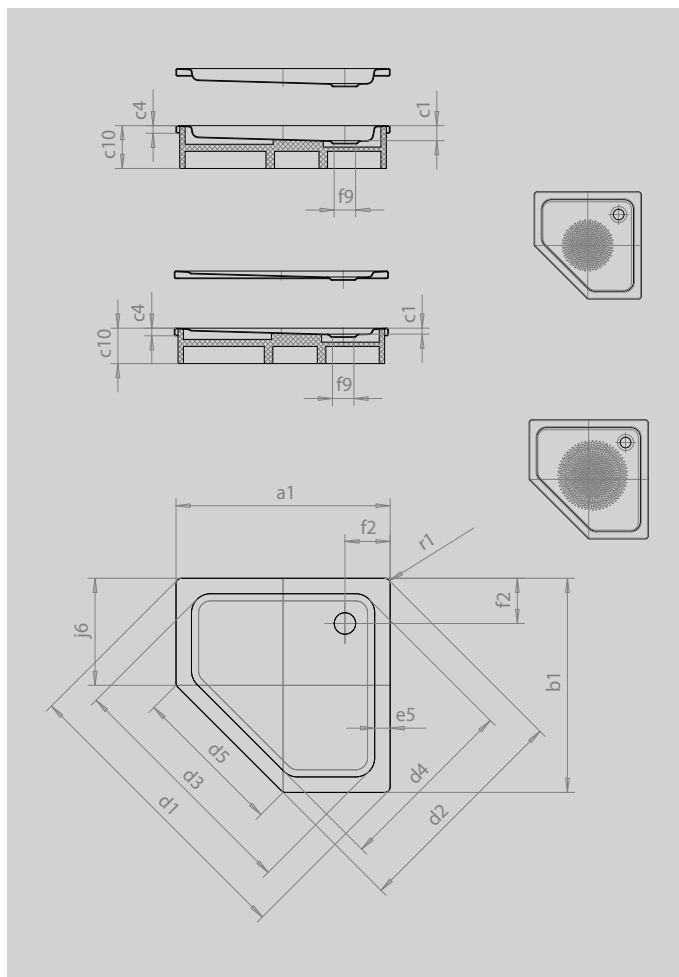

Similar illustration



Model		673
External length	a_1	1000 mm
External width	b_1	1000 mm
Depth inside	c_1	65 mm
Height of rim	c_4	32 mm
Height with low-profile support	c_{16}	49 mm
Width across corners - external length	d_1	1395 mm
Width across corners - external width	d_2	1051 mm
Width across corners - internal length	d_3	1164 mm
Width across corners - internal width	d_4	871 mm
Width of access area	d_5	707 mm
Width of rim	e_5	65 mm
Distance bath edge to centre of waste hole	f_2	190 mm
Diameter of waste hole	f_9	Ø 90 mm
Side length	j_6	500 mm
External radius	r_1	23 mm
Net weight		24 kg
Diameter of anti-slip		Ø 588 mm