

SCONA

- harmonious design with centrally-placed waste
- can be installed absolutely flush to floor
- made of KALDEWEI steel enamel
- flush-fitting recessed waste cover (only in combination with the KA 90 waste fittings)

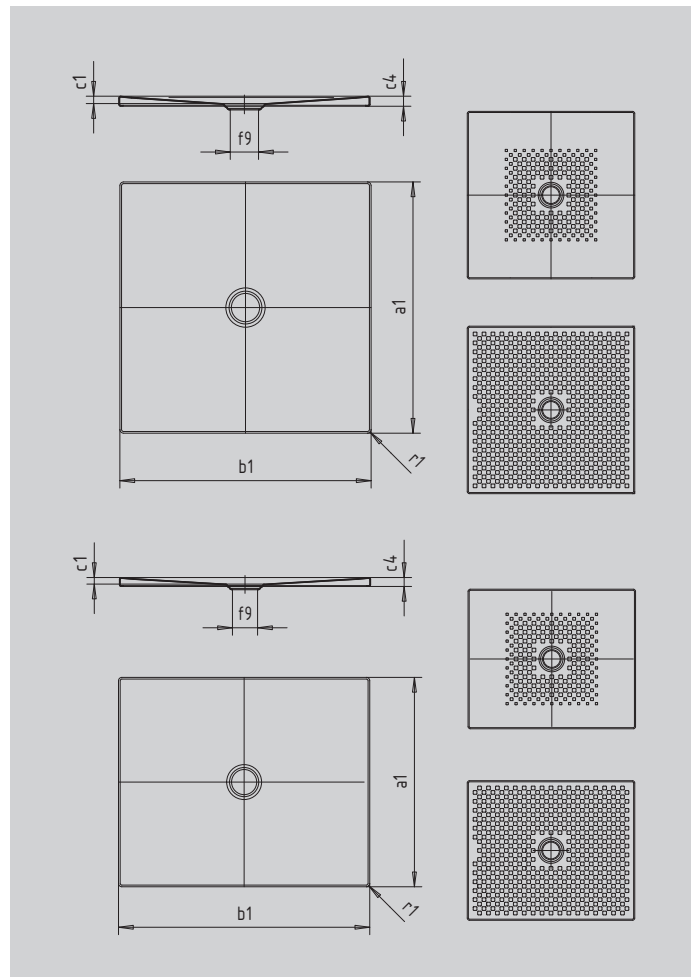

Similar illustration



SECURE⁺

Model		908
External length	a_1	750 mm
External width	b_1	800 mm
Depth inside	c_1	23 mm
Height of rim	c_4	32 mm
Height with low-profile support	c_{16}	49 mm
Diameter of waste hole	f_9	Ø 90 mm
External radius	r_1	12 mm
Net weight		16 kg
Anti-slip		492 x 492 mm
Full anti-slip		692 x 740 mm
SECURE PLUS		full base

KALDEWEI