

# SCONA WITH LOW PROFILE SUPPORT

- harmonious design with centrally-placed waste
- made of KALDEWEI steel enamel
- flush-fitting recessed waste cover (only in combination with the KA 90 waste fittings)

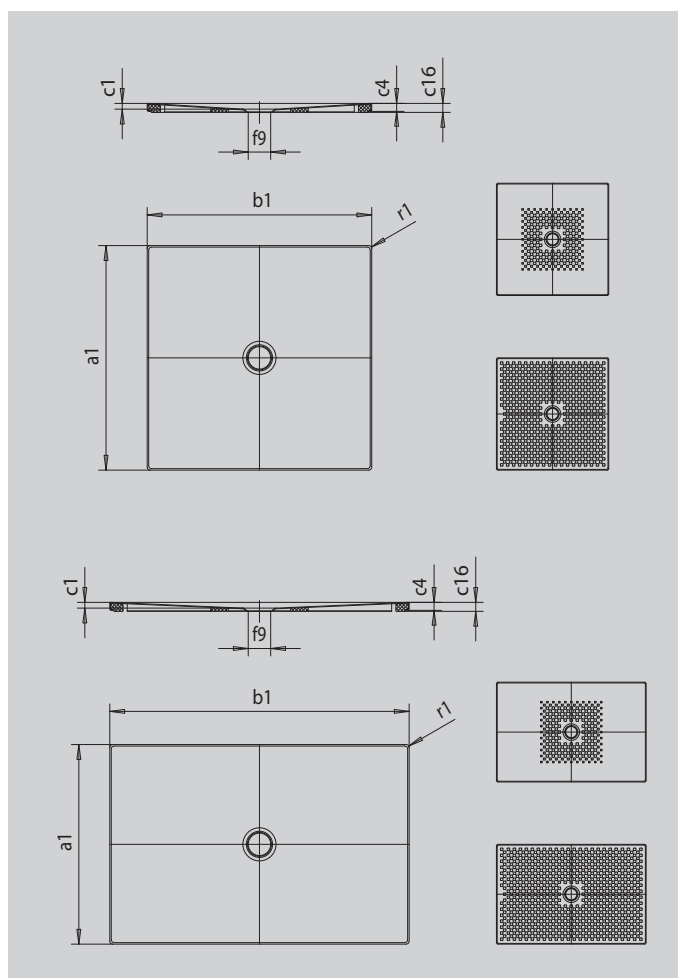

Similar illustration



SECURE<sup>+</sup>

Model		912
External length	$a_1$	750 mm
External width	$b_1$	900 mm
Depth inside	$c_1$	23 mm
Height of rim	$c_4$	32 mm
Height with low-profile support	$c_{16}$	37 mm
Diameter of waste hole	$f_9$	Ø 90 mm
External radius	$r_1$	12 mm
Net weight		18 kg
Anti-slip		492 x 492 mm
Full anti-slip		692 x 836 mm
SECURE PLUS		full base

**KALDEWEI**