

# SCONA WITH LOW PROFILE SUPPORT

- harmonious design with centrally-placed waste
- made of KALDEWEI steel enamel
- flush-fitting recessed waste cover (only in combination with the KA 90 waste fittings)

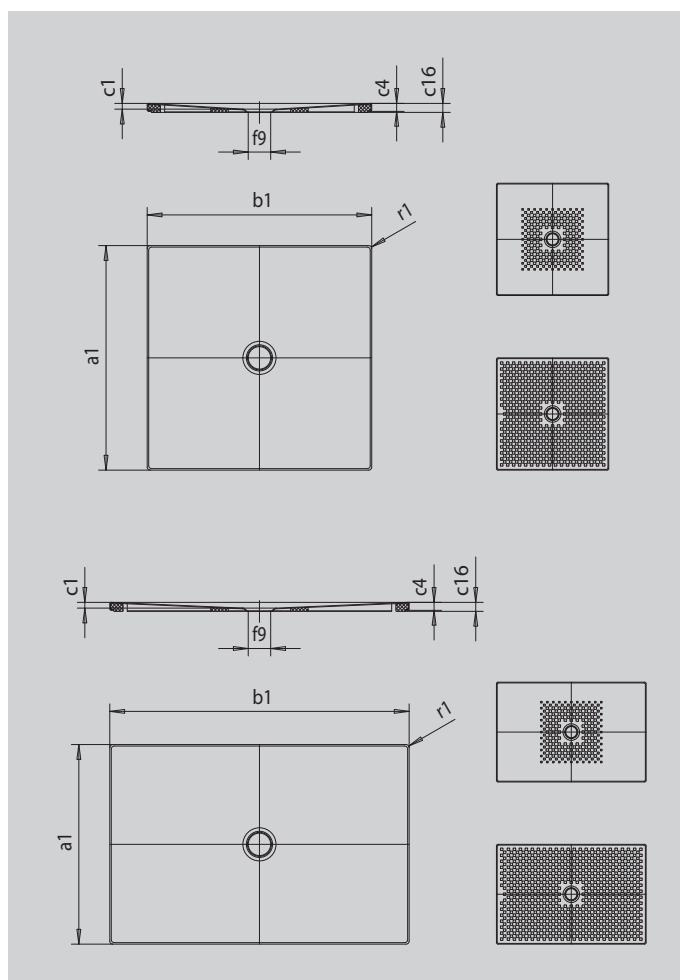

Similar illustration



SECURE<sup>+</sup>

|                                 |          |               |
|---------------------------------|----------|---------------|
| Model                           |          | 991           |
| External length                 | $a_1$    | 700 mm        |
| External width                  | $b_1$    | 1700 mm       |
| Depth inside                    | $c_1$    | 23 mm         |
| Height of rim                   | $c_4$    | 32 mm         |
| Height with low-profile support | $c_{16}$ | 37 mm         |
| Diameter of waste hole          | $f_9$    | Ø 90 mm       |
| External radius                 | $r_1$    | 12 mm         |
| Net weight                      |          | 30 kg         |
| Anti-slip                       |          | 492 x 492 mm  |
| Full anti-slip                  |          | 644 x 1604 mm |
| SECURE PLUS                     |          | full base     |

**KALDEWEI**