

SILENIO BUILT-IN WASHBASIN

- fluid and sensually modern design all at once
- optimum comfort through generous dimensioning of the washbasin
- soft, organic interior shape
- geometry allows fittings with short spout leaving ample space for washing
- together with the SILENIO bath and SCONA shower surface, they form a perfect bathroom fitted out entirely with steel enamel
- designed by Anke Salomon

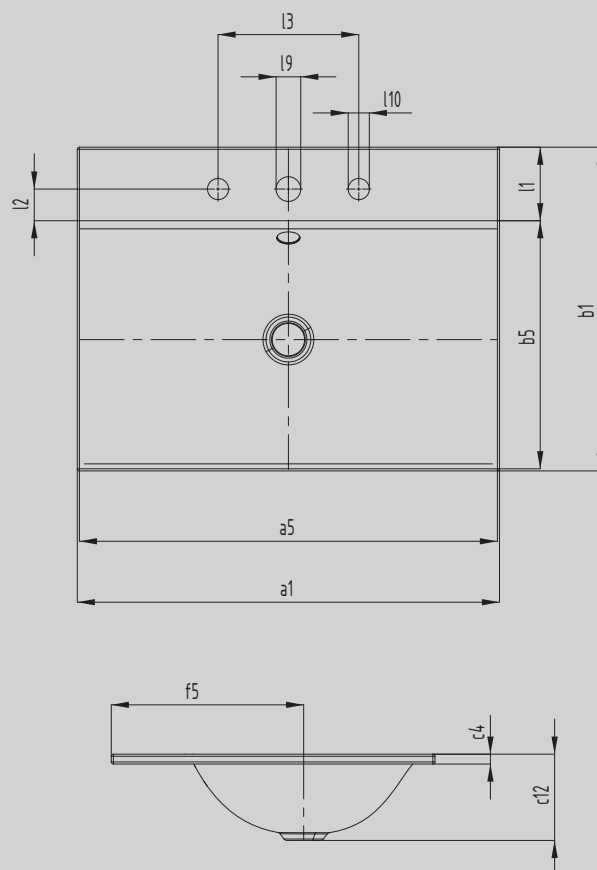

Similar illustration



Model		3037
External length	a_1	600 mm
Internal length	a_5	594 mm
External width	b_1	460 mm
Internal width	b_5	353 mm
Height of rim	c_4	14 mm
Distance basin surface to bottom edge of waste hole	c_{12}	123 mm
Distance rear edge to centre of waste hole	f_5	274 mm
Depth of tap deck	l_1	105 mm
Distance tap holes to edge	l_2	45 mm
Distance external tap holes (for 3 tap holes)	l_3	200 mm
Diameter of centre tap hole	l_9	Ø 35 mm
Diameter of outside tap hole (for 3 tap holes only)	l_{10}	Ø 30 mm
Net weight		7 kg