

DUSCHPLAN

- a classic among shower trays
- modern, clear design only 65 mm deep
- available in rectangular or square design
- made of KALDEWEI steel enamel
- flush-fitting recessed waste cover (only in combination with the KA 90 waste fittings)



Similar illustration

Model 542	KA 90 horizontal	KA 90 flat	KA 90 vertical
Total height	145	125	49
Fitting height	80	60	80

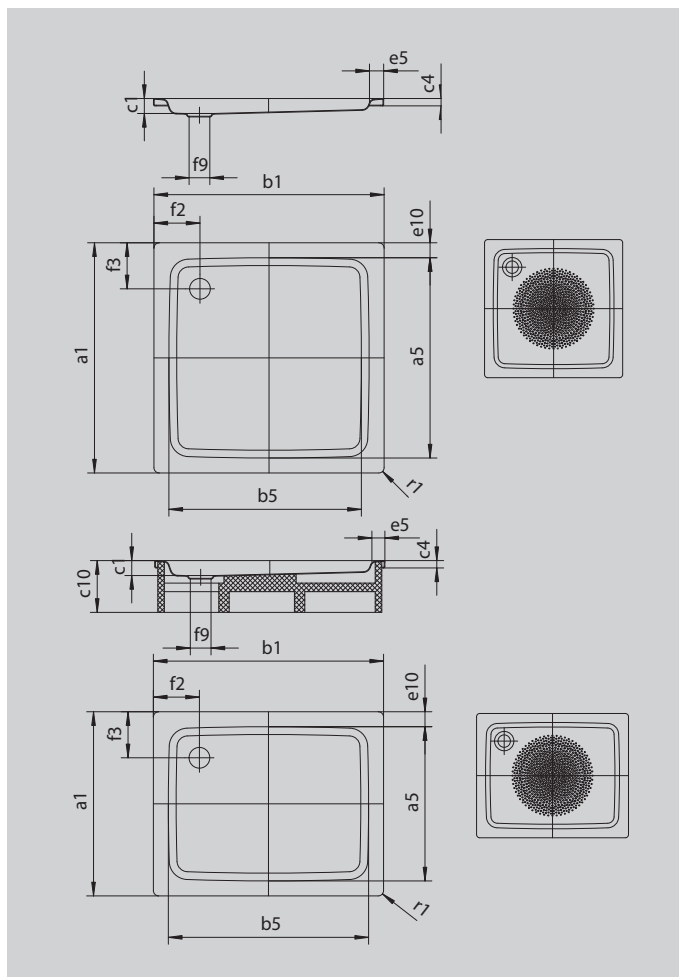

Model		542
External length	a_1	800 mm
Internal length	a_5	670 mm
External width	b_1	800 mm
Internal width	b_5	670 mm
Depth inside	c_1	65 mm
Height of rim	c_4	32 mm
Height with support	c_{10}	160 mm
Width of rim	e_5	65 mm
Distance bath edge to centre of waste hole	f_2	200 mm
Diameter of waste hole	f_9	Ø 90 mm
External radius	r_1	12 mm
Net weight		20 kg
Diameter of anti-slip		Ø 435 mm