

SUPERPLAN ZERO

- accessible from three sides without steps
- waste especially close to the wall and an even slope for a consistently level surface
- generous design, seamless transitions for small and large bathrooms
- clear edges and sharp corner radii for minimum joints and a uniform look
- low installation height for easy, floor-level installation – also for large formats



Similar illustration

Model 1580	KA 90 horizontal	KA 90 flat	KA 90 vertical
Total height	100	80	49
Fitting height	80	60	80

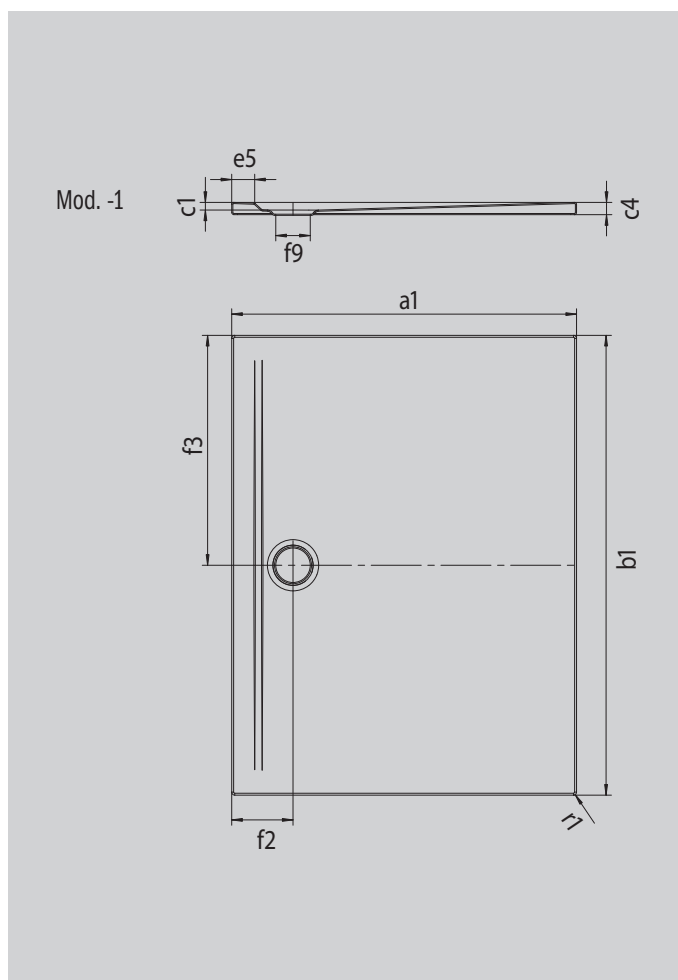

ANTISLIP
SECURE⁺

Model		1580
External length	a_1	1000 mm
External width	b_1	1400 mm
Depth inside	c_1	20 mm
Height of rim	c_4	32 mm
Width of rim	e_5	60 mm
Diameter of waste hole	f_9	Ø 90 mm
Distance bath edge to centre of waste hole	$f_2; f_3$	160; 700 mm
External radius	r_1	8 mm
Net weight		36 kg
ANTI-SLIP SECURE PLUS		full base

KALDEWEI