

# SCONA

- harmonious design with centrally-placed waste
- can be installed absolutely flush to floor
- made of KALDEWEI steel enamel
- flush-fitting recessed waste cover (only in combination with the KA 90 waste fittings)

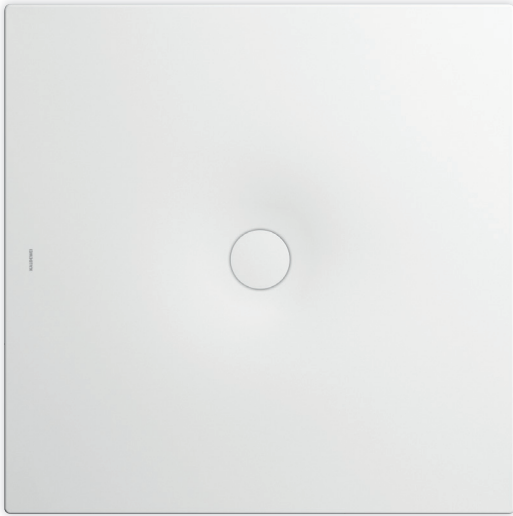

Similar illustration

Model 940	KA 90 horizontal	KA 90 flat	KA 90 vertical
Total height	103	83	49
Fitting height	80	60	80

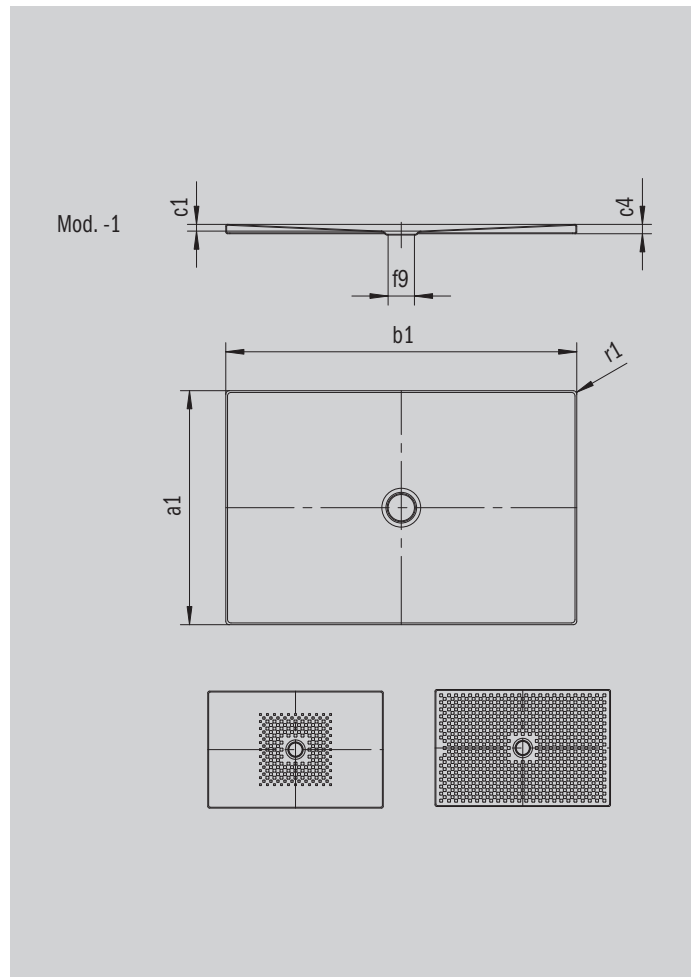

ANTISLIP  
**SECURE<sup>+</sup>**

Model		940
External length	$a_1$	700 mm
External width	$b_1$	900 mm
Depth inside	$c_1$	23 mm
Height of rim	$c_4$	32 mm
Diameter of waste hole	$f_9$	Ø 90 mm
External radius	$r_1$	12 mm
Net weight		17 kg
Anti-slip		492 x 492 mm
Full anti-slip		644 x 836 mm
ANTI-SLIP SECURE PLUS		full base

**KALDEWEI**