

SUPERPLAN PLUS

- elegant, puristic design
- can be installed to be absolutely flush with the floor
- maximum standing comfort thanks to the flat enamelled waste cover that is set flush in the shower tray
- made of KALDEWEI steel enamel



Similar illustration

Model 480	KA 120 horizontal	KA 120 flat	KA 120 vertical
Total height	108	88	49
Fitting height	83	63	83

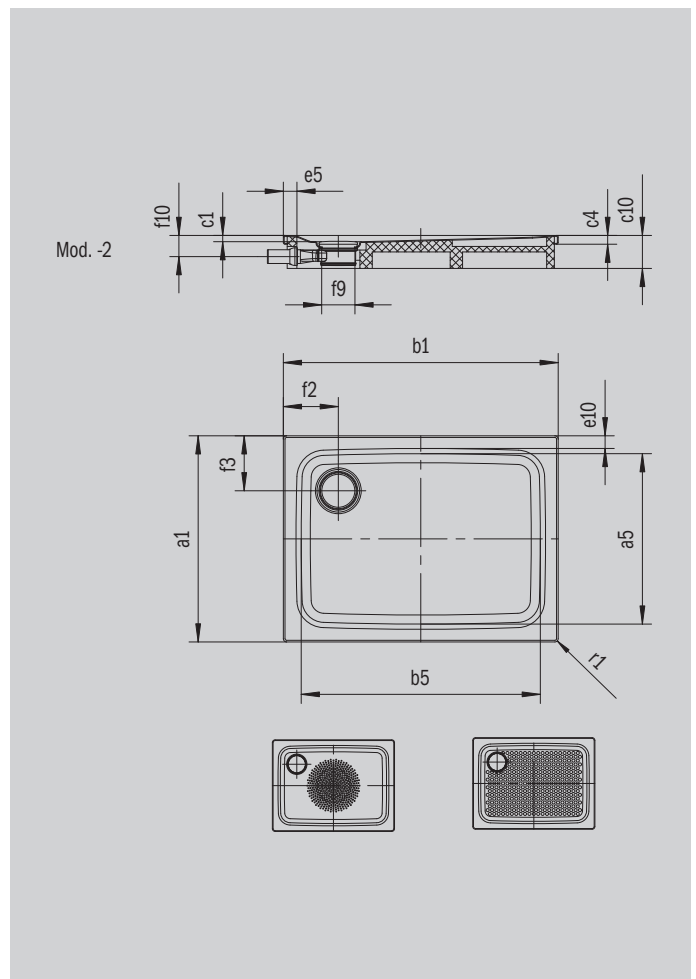

ANTISLIP
SECURE⁺

Model		480
External length	a_1	900 mm
Internal length	a_5	790 mm
External width	b_1	1100 mm
Internal width	b_5	990 mm
Depth inside	c_1	25 mm
Height of rim	c_4	32 mm
Height with support	c_{10}	120 mm
Total height (height with bottle trap)	c_{17}	109 mm
Width of rim	e_{10}, a_5	50; 50 mm
Diameter of waste hole	f_9	Ø 120 mm
Bottle trap connection height	f_{10}	78 mm
Distance bath edge to centre of waste hole	f_{21}, f_3	200; 200 mm
External radius	r_1	12 mm
Net weight		26 kg
Diameter of anti-slip		Ø 588 mm
Full anti-slip		649 x 853 mm

ANTI-SLIP SECURE PLUS

full base

KALDEWEI