

# NEXSYS

- Absolutely floor-level shower surface made of KALDEWEI steel enamel
- Design: Absolutely flat surface - no inner contours for a generous standing area and a harmonious bathroom interior.  
Discreet waste channel with flush design cover.
- Pre-assembled 4-in-1 system consisting of enamelled shower surface, waste channel, all-round sealing tape, slope support with counter slope between channel and wall. The system is completed by the desired waste fitting incl. hair catcher and an exclusive design cover from the optional extras.
- Accessories included: Sound insulation tape
- Low total height from 86 mm (depending on size and waste fitting)



Similar illustrations

Mod. 2618

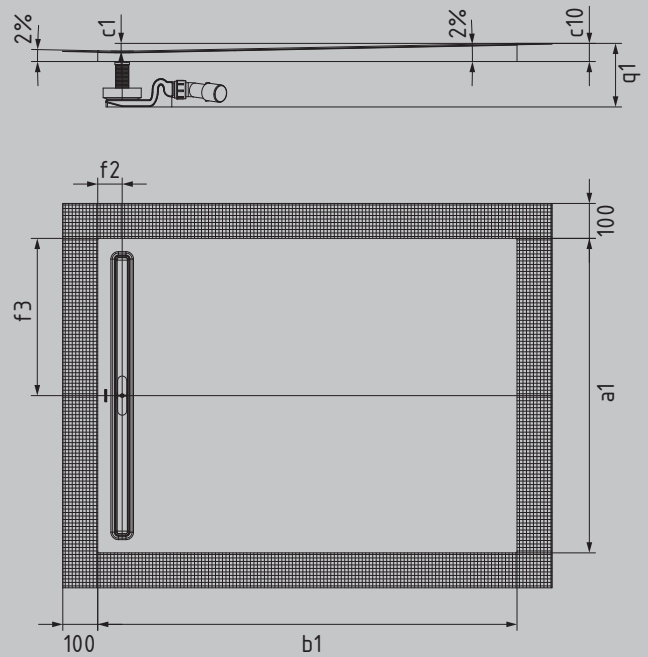

Model No.		2610	2611	2613	2614	2616	2620
External length	a1	800	800	800	900	900	1200 mm
External width	b1	800	900	1000	1000	1100	1200 mm
Internal depth	c1	12	14	16	16	18	20 mm
Height with support	c10	46	46	48	48	50	52 mm
Distance tray edge to centre of waste hole	f2; f3	70; 400	70; 400	70; 400	70; 450	70; 450	70; 600 mm
Weight of the enamelled shower tray in kg		16	18	20	22	24	35 kg
Total height (height with KA 4121 waste fitting)	q1	min. 104	min. 106	min. 108	min. 108	min. 110	min. 112 mm
		max. 174	max. 176	max. 178	max. 178	max. 180	max. 182 mm
Total height (height with KA 4122 waste fitting)	q1	84	86	88	88	90	92 mm