

# SCONA

- harmonious design with centrally-placed waste
- can be installed absolutely flush to floor
- also available in the shades of the Coordinated Colours Collection
- made of KALDEWEI steel enamel
- flush-fitting recessed waste cover (only in combination with the KA 90 waste fittings)



Similar illustration

	Combined Tray & Waste depth	Waste fitting depth
KA 90	103	81
KA 90 extra flat	92	70
KA 90 ultra flat	83	61
KA 90 vertical	49	81

See page 291.

Model 968

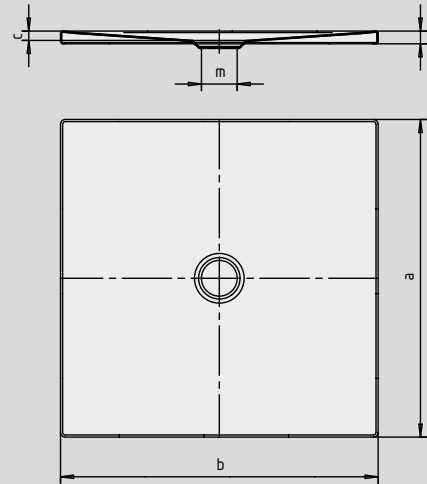

Model 977

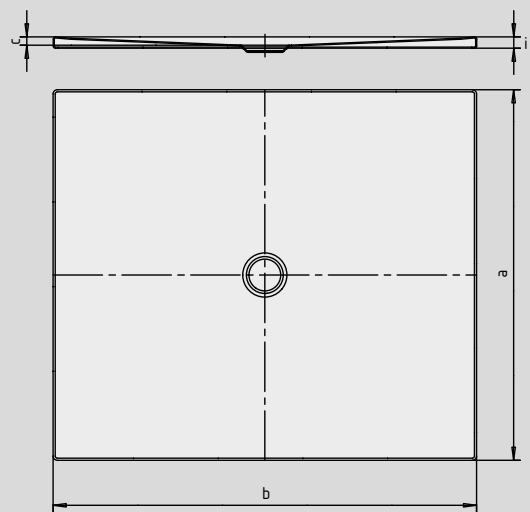

SECURE<sup>+</sup>

Model No.	968	969	970	972	974	975	976	919	977
External length	a	1200	800	900	1000	700	750	800	1000 mm
External width	b	1200	1300	1300	1300	1400	1400	1400	1400 mm
Depth	c	23	23	23	23	23	23	23	23 mm
Height of rim	i	32	32	32	32	32	32	32	32 mm
Diameter of drain hole	m	90	90	90	90	90	90	90	90 mm
Weight of the enamelled shower tray in kg		37	26	30	34	25	27	29	31
Anti-slip		492 x 492	492 x 492	492 x 492	492 x 492	492 x 492	492 x 492	492 x 492	492 x 492 mm
Full anti-slip		1172 x 1172	740 x 1220	836 x 1220	932 x 1220	644 x 1316	692 x 1316	740 x 1316	836 x 1316
SECURE PLUS		all-over	all-over	all-over	all-over	all-over	all-over	all-over	all-over

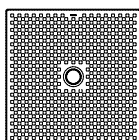

The TÜV Rheinland confirms the following properties of KALDEWEI's anti-slip, full anti-slip and SECURE PLUS finish:

- Assessment group **B** for wet barefoot areas (**DIN 51097**)
- Assessment group **R 10** for slip-resistant properties in work rooms and areas with an increased risk of slipping (**DIN 51130**)

All SCONA models are available either with anti-slip, full anti-slip or SECURE PLUS.

Model 968 with full anti-slip or SECURE PLUS fits DIN barrier-free 18040-2.